

Measurements

SALZBURG S

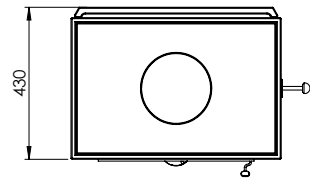

SALZBURG S - CONCRETE TOP PLATE = MM

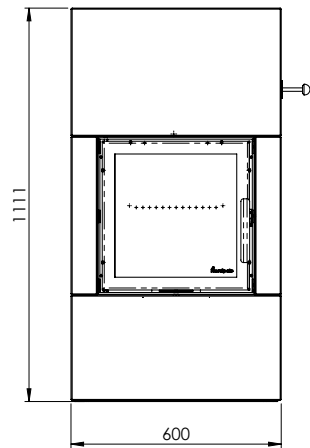

SALZBURG S - HOT TOP PLATE = MM

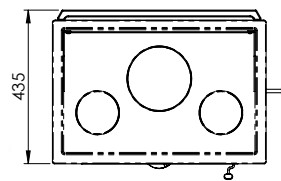
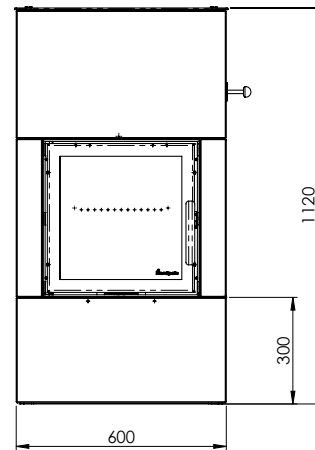

SALZBURG S - CONCRETE TOP PLATE/WOOD SHELF = MM

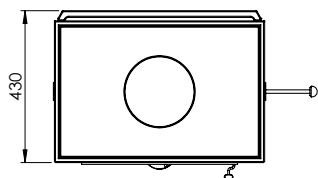
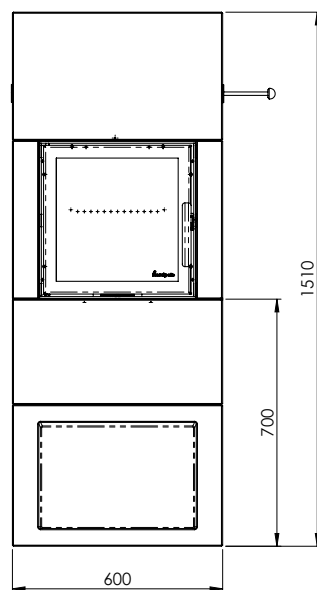

Measurements

SALZBURG S



SALZBURG S - CONCRETE TOP PLATE = CHIMNEY/AIR/MM

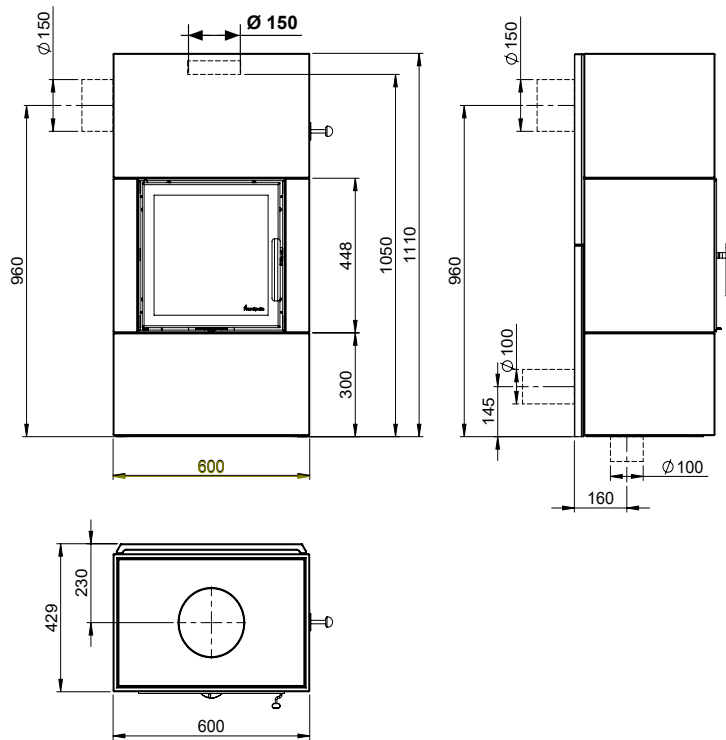

SALZBURG S - HOT PLATE = CHIMNEY/AIR/MM

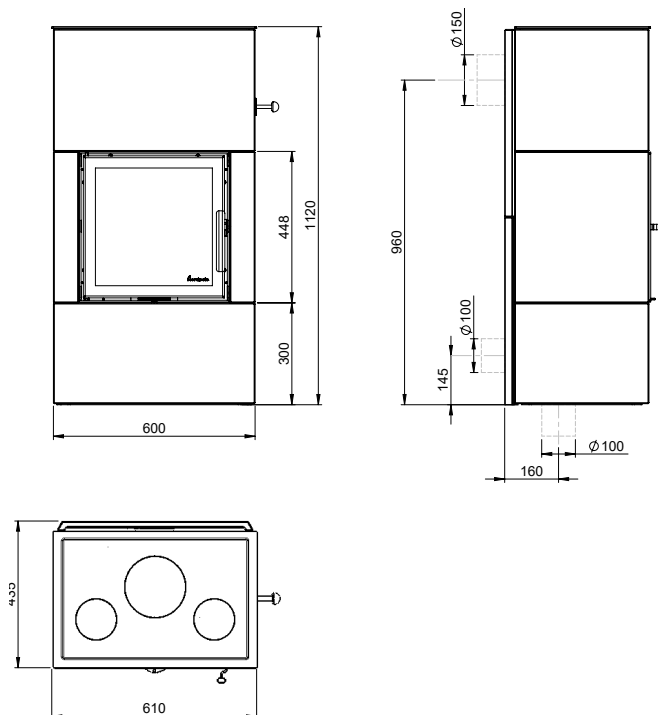

Measurements

SALZBURG S



SALZBURG S - CONCRETE TOP PLATE WITH WOOD SHELF = CHIMNEY/AIR/MM

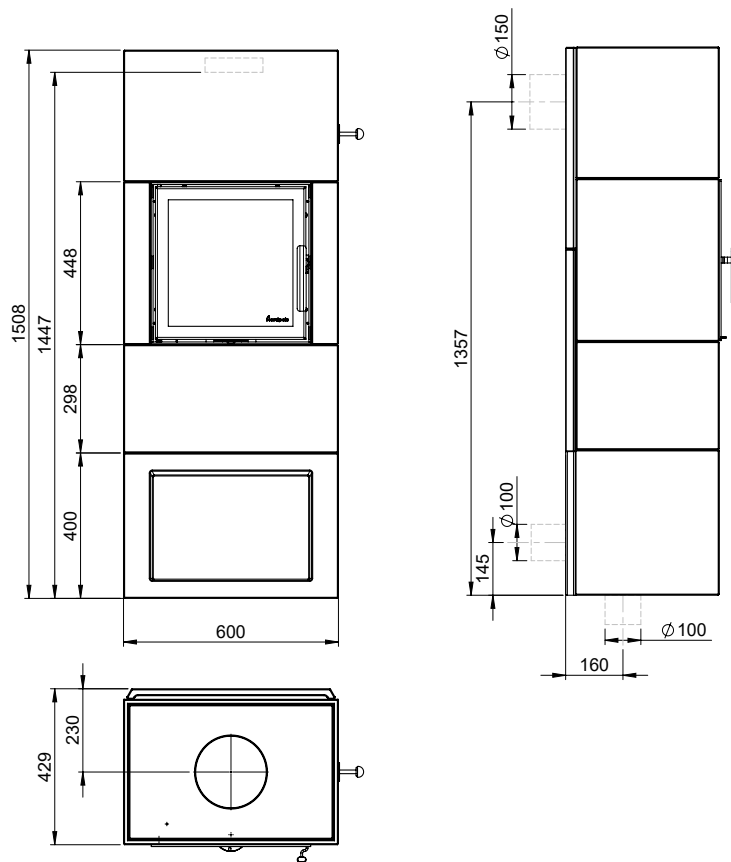



Safety distances

SALZBURG S



FIG 1 = MM

-  =Brannmur/Brandmur/Palomuuri/Firewall/Mur parfeu/Hitzeschutzwand
-  =Brennbart materiale/ Brännbart material/ Tulenarka materiaali/Combustible material/

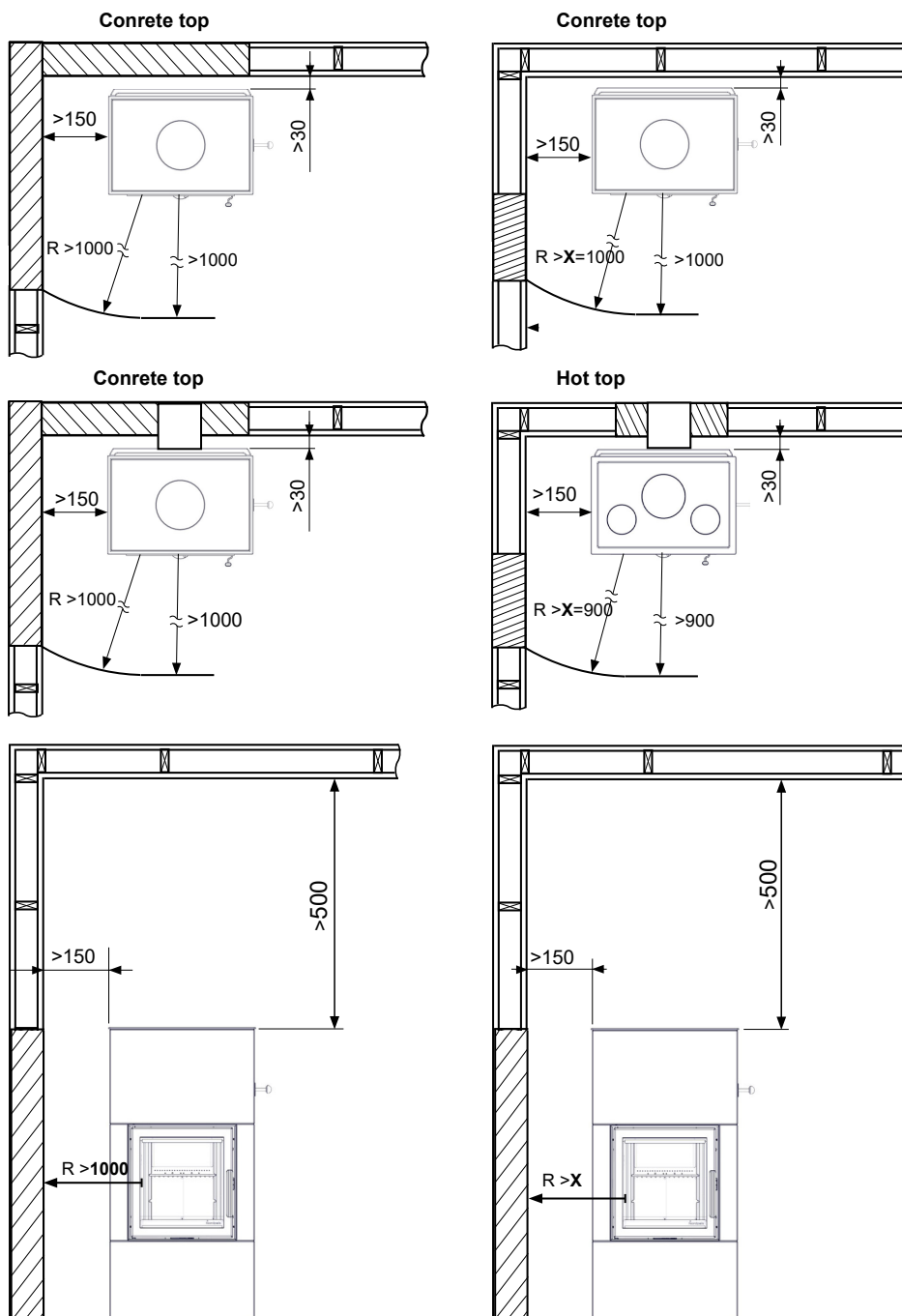



Safety distances

SALZBURG S



FIG 2 = MM

-  = Brannmur/Brandmur/Palomuuri/Firewall/Mur parfeu/Hitzeschutzwand
-  = Brennbar materiale/ Brännbart material/ Tulenarka materiaali/Combustible material/

Concrete top

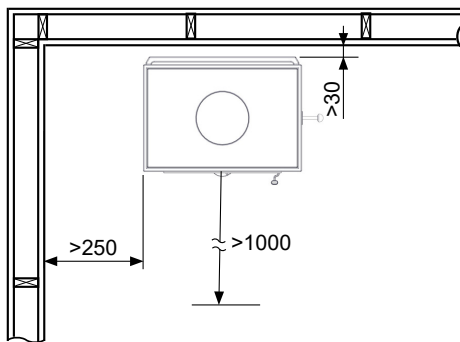

Hot top

